

RESEARCH ARTICLE

THE IMPORTANCE OF SUSTAINABLE MANAGEMENT OF ACID SOILS IN THE HUMID TROPICS UNDER CLIMATE CHANGE AND THE FUTURE RESEARCH DIRECTIONS

Patrick S. Michael^{a,b,*}^aDepartment of Agriculture, Environmental Research and Management Center^bPNG University of Technology, PMB, Lae, MP 411, Papua New Guinea*Corresponding Author Email: patrick.michael@pnguot.ac.pg

This is an open access article distributed under the Creative Commons Attribution License CC BY 4.0, which permits unrestricted use, distribution, and reproduction in any medium, provided the original work is properly cited.

ARTICLE DETAILS

Article History:

Received 23 August 2023
Revised 26 September 2023
Accepted 24 October 2023
Available online 06 November 2023

ABSTRACT

Oxisols, ultisols, and acid sulfate soils are the three common acid soils in the humid tropics. These soils are a concern agriculturally and environmentally because of acidity, cationic toxicity, and low nutrient availability, and there is a need to manage them. This review has synthesized relevant research from the past 20 years and establishes how acid soils were formed, their causes of acidity, and their impacts. Sustainable practices such as protecting the natural forest, using organic matter, and alternative soil nutrient sources to manage acid soil's acidity, toxicity, and low nutrients are covered. Research is needed to improve agricultural productivity in the farms and protect the various ecological services provided to humanity in the general environment in the light of climate change. These research needs were synthesized and presented as future research directions.

KEYWORDS

Acid soils, humid tropics, lime, nutrient limitation, sustainable management, toxicity

1. INTRODUCTION

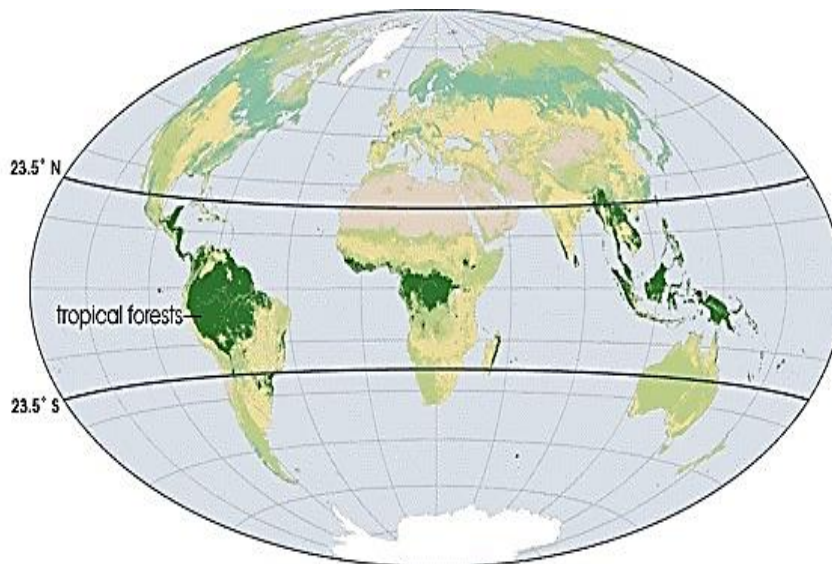

Figure 1: The humid tropics are mainly found between 23.5°S and 23.5°N of the equator covering 20 percent of the land and 40 percent of the ocean surface (World Geography, 2023).

An acid soil is a soil type that has a pH value of 5.5 units, with acid sulfate soils (ASS) of pH <4.5 units being the extreme type (Michael et al., 2012; 2015). Most acid soils are Ultisols (Arisols, Nitisols, Alisols, Podzols, and Dystric subgroups) and Oxisols (Ferralsols) (IUSS Working Group, 2015).

These acid soils are formed from parent materials low in carbonate materials, are influenced directly by climate and are found in the humid temperate zone (covered by coniferous forest) and in the humid tropics (covered by tropical rainforest and savanna grassland). Figure 1 shows the

Quick Response Code



Access this article online

Website:
www.efcc.com.my

DOI:
10.26480/efcc.01.2023.29.40

map of the humid tropics. On estimation, 50% of the land area of the tropics is acid upland soil, of which 22% are Oxisols and 11% are Ultisols, accounting for 90% of the tropical land. Oxisols with kaolinite being the dominant clay mineral are essential in South America and Africa but less important in Asia. These soils have good physical soil properties but are highly weatherable; therefore, low in K^+ , Ca^{2+} , and Mg^{2+} contents because of leaching losses. Poor base saturation (the sum of base cations (Ca^{2+} , Mg^{2+} , K^+ , and Na^+ held onto the soil exchange sites divided by the total CEC and expressed as a percentage) and water retention are the severe constraints of soil fertility in these soil orders. In southeast Asia, Ultisols are significant and account for 50% of the landmass, with a base saturation of 35%.

The general of Oxisols and Ultisols is shown in Fig. 2. These acidic soils are deficient in major crop nutrients (P deficiency and fixation), low cation-exchange-capacity (CEC), high exchangeable Al, and toxicities of several trace elements (Mn and B). The high concentration of Al stunts roots and prevents them from efficiently utilizing soil water and nutrients, binds with phosphate groups, and forms Al-phosphate, precipitated or adsorbed to soil particles, leading to P deficiency (Fageria and Nascente, 2014). When the soil pH is below 5.6 units, Mn solubility, and toxicity increase sharply, causing browning of leaves and disrupting photosynthesis. When the soil pH drops to <4.8 units, Al and Mn toxicity and probably Fe occurs. In addition, acid soils' moisture stress, high surface temperature, and erosion become common characteristics.

Under natural, undisturbed Oxisols (Ferralsols) and Ultisols (Acrisols) conditions, extensive areas of the tropics are covered by tropical rainforest and produce up to 35 tonnes of dry matter per year, sufficient to maintain soil fertility, ameliorate acid, reduce surface temperature and increase moisture retention. Changes in the natural rainforest due to anthropogenic activities, for instance, land clearing and agriculture, have resulted in most areas being converted to savanna grassland, predominated by cogon grass (*Imperata cylindrica*). The dominant land use system in the tropics is shifting cultivation and is only limited to permanent agriculture (mainly plantation agriculture). Under anthropic savanna, plantation agriculture (or shifting agriculture) conditions and increasing loss of the natural tropical rainforest, the turnover of dry matter per year is less, resulting in a loss in soil fertility and other essential soil characteristics. Under these conditions, the issue of sustainable land use and management of the acid soil arises as significant concerns.

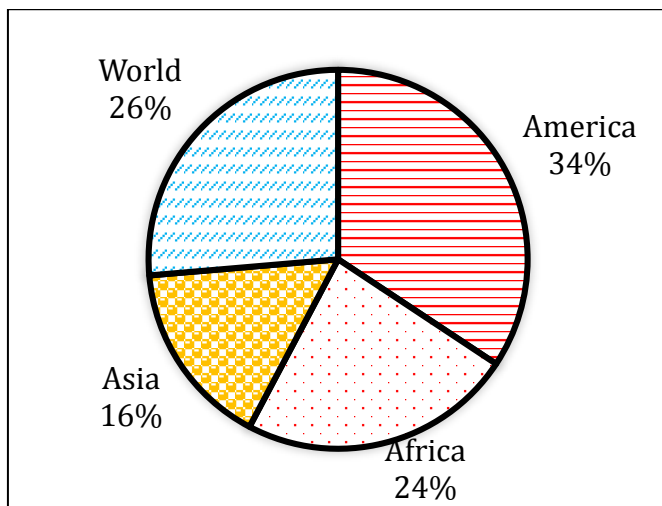

Figure 2: General distribution of Oxisols and Ultisols.

The most common approach to managing the acid soils of the tropics, and even the humid tropics, is to leave them under natural rainforest cover. Doing this would help keep the acid soils untouched, maintain soil fertility, retain moisture, and prevent soil nutrient limitation. This is, however, not possible as the need to feed more people has arisen, requiring more land to be cleared and food produced. Nearly 70% of the tropical rainforests have been removed due to plantation agriculture, logging, or urbanization, making the soil in the humid tropics go acidic. Under any land use and management system, the established approach is to manage the acid soil. Where the soil has gone acid (acid soil), the principle is to contain the acid. The management strategy available includes the application of an alkaline material, a proper fertilizer use plan to manage deficient nutrients, and consideration of an appropriate use of land plan (e.g., choice of machinery) to protect the topsoil, retain organic matter, and conserve moisture, including improvement of the biological, chemical, and physical properties of the acid soil.

The aims of this synthesis of the literature on acid soils are: (i) to clearly establish how acid soils, in particular Oxisols and Ultisols that dominate in the humid tropics were formed and their impacts under natural and general land use and management conditions, and (ii) to point out the approaches to sustainably manage acid soils in the humid tropics. ASS have been considered as an extreme type of acid soil in the humid tropics and are given equal consideration.

2. METHODOLOGY

The study systematically reviewed and synthesized existing literature since 2000 on acid soils in the tropics by comprehensively searching through Google Scholar (www.scholar.goggle.com) and Research Gate (<https://www.researchgate.net>). The literature searched were carefully selected to capture 'main acid soils in the tropics', nutrient limitations in acid soils, acid soil toxicity, and acid soil management (use of liming and organic matter'. More than 250 papers were identified to be suitable but less than 150 of them were reviewed to cover the content, including the study design, methodology, and findings. This was followed by a qualitative analysis approach to synthesize the results of the studies and identify key themes. A set of pre-defined research questions, such as acid soils in the tropics, different types of acid soils in the tropics, causes of acidity, impacts of acid soils, nutrient deficiency in acid soils, management of acid soils, and management of nutrient deficiency in acid soils guided the analysis component. The study identified gaps in existing knowledge and highlighted potential areas for future research, including using advanced technology in the sustainable management of acid soils. The study provides a comprehensive overview of past research on tropical acid soils. It identifies future research directions that could pave the way for sustainable management of acid soils, particularly in the humid tropics.

3. COMMON ACID SOILS

3.1 Oxisols And Ultisols

Oxisols (Ferralsols) and Ultisols (Acrisols), with perhaps a few Alfisols, are highly weathered and leached acid soil orders (Fig. 1) formed in the humid climates of the tropics. Oxides of Fe and Al, and H and Al ions dominate the clay particles of the Oxisols and Ultisols. These soil orders are low in natural fertility (Ca^{2+} , Mg^{2+} , K^+) and high in soil acidity (H^+ , Al^{3+} , Fe, and S). Compared to Ultisols, Oxisols are resistant to erosion, stable, have low shrink-swell properties, and have insufficient capacity to retain the addition of lime and fertilizer. Eight percent of the global ice-free land is covered by these two soil orders, with Oxisols located primarily in the equatorial regions occupying 22% of the land in the tropics. Similarly, Ultisols predominate 11% of the land in the tropics (soils of south-eastern USA, China, South America, and equatorial regions of Africa). The low natural soil fertility and soil acidity make these soil orders require intensive fertilizer and lime application to improve productivity.

3.1.1 Causes and Impacts Of Acidity

In Oxisols and Ultisols (Fig. 1), and even in ASS (section 3.2), the causes of acidity and impacts on the general soil-water-plant environment have no direct relationship with the H^+ concentration in a soil solution but generation, transportation, and accumulation of common toxic soil constituents. These soil constituents either have negative ecological and environmental (soil, water, and plant systems) impacts due to toxicity or lead to nutrient deficiencies and affect the biological and physiochemical components. The most common soil constituents responsible for ecotoxicity and nutrient deficiencies are Al, Mn, Fe, and S (common in ASS). The origin, nature of toxicity, and processes that lead to a nutrient deficiency of these environmental stresses are important (Xu et al., 2002).

Soil toxicity and nutrient deficiency are two main reasons acid soils are a concern in the humid tropics, apart from the acidic nature *per se*. It is common knowledge that a high concentration of H^+ (pH<4.5 units) does not affect root growth directly but causes dissociation reactions in the soil matrix in which metals, metalloids, and minerals are held. These reactions result in releasing and accumulating acid minerals (e.g., Al^+ , Mn, and Fe), most often leading to toxicity (Michael et al., 2015). The dissociation reactions further leach nutrients (e.g., K^+ , Mg^{2+} , Ca^{2+}) and resultant deficiencies affecting soil health. Formation of complexes, e.g., Al-phosphates, which are strongly adsorbed or precipitated, enhance nutrient deficiency in the soil.

Aluminium: Al exists in the soil in a variety of forms. In high to intermediate soil pH, exchangeable Al is tightly held to the negative charges of clay ciliates, sesquioxide-coated systems such as $Al(OH)_2^+$ and organic matter. When the soil pH drops below 5 units, e.g., 4.8 units, exchangeable Al and the concentration in soil solution increases, leading

to toxicity and deficiencies of many nutrients. In most soils, a concentration of 2 – 5 ppm is toxic to the roots of most susceptible plants, and above 5 ppm is harmful to tolerant plants. The effect of Al toxicity on the roots of plants and most plants growing in soil with high concentration have stunted roots caused by swelling and fewer root hair that prevent the proper acquisition of soil minerals and water.

In susceptible plants, Al binds to phosphate groups in the nucleic acid and inhibits cell division, affecting phosphokinase and ATPase activity and inhibiting the uptake and translocation of P. In some higher plants, however, tissue concentrations of Al may range from 200 – 5000 ppm, e.g., in leaves of tea plants. In such highly tolerant plants, there are no ill effects because organic compounds detoxify toxicity. Aluminium easily forms complexes with other soil minerals, e.g., Al-phosphate, which are strongly adsorbed or precipitated, making them deficient in the soil.

Manganese: Mn is the second mineral whose concentration increases as soil pH decreases and becomes exceptionally toxic. In typical plants, Mn concentration is 40 – 120 ppm, and leaves of deficient plants contain about 15 – 25 ppm. Mn in a solution concentration of 1 – 4 ppm at a soil pH of 5.6 units it has no toxic effects on plant growth. When the soil pH drops to between 5.5 – 4.8 units, Mn toxicity develops and becomes severe, more pronounced with increasing soil moisture and decreasing aeration. Mn availability is also dependent on soil adsorption and root exudate chelation. Plants affected by Mn toxicity have reduced chlorophyll content in the leaves, and in most plants, brown spots become common in the older leaves, caused by either an auxin deficiency, high indole acetic acid oxidase activity, or toxic effects on the biochemical pathways.

Under general soil use and management conditions, Mn toxicity is high with the application of acid-forming fertilizers, e.g., high rate of superphosphate and nitrate (NO₃), cultivation of plants that have low affinity to silicon or cultivation in soil deficient of cations (Ca, Fe, Mg, and P). In soils of high adsorption capacity, plant availability of nutrients is low, and plants avoid Mn toxicity by restricting absorption, translocation, and even greater tolerance by detoxifying the effects of organic compounds in the tissues. Tissue accumulation of Mn in plants may vary, with some having a high concentration in the shoots and low in other parts, such as the roots. Plants such as rice and pumpkin accumulate Mn more highly in the shoots than alfalfa, tomato, and barley, whose accumulation in the roots was higher. Uptake and translocation are concentration and plant species, with some plants accumulating increased amounts even when the soil solution concentration is low. Contrary to the soil solution concentrations, the opposite is true when tissue accumulation is low. In rice, the presence of silicon decreases Mn uptake and increases tissue tolerance. Tolerance to Mn is variable, and for most plant concentrations between 40 – 120 ppm is normal and is considered excessive when above 180 ppm.

Iron: Iron (Fe) toxicity in Ultisols, sandy soils, or ASS in the humid tropics is a concern, particularly in the lowlands where rice is grown. Iron occurs in a wide range of soil types. Still, Fe-toxic soils have low pH, low cation exchange capacity (CEC), low exchangeable K content, and high reducible Fe. Under general soil use conditions, Fe-toxicity is associated with deficiencies of P and Zn (Kirk, 2004) and is quite common in anoxic conditions. Under anoxic soil conditions, molecular oxygen gets depleted, followed by NO₃⁻, Mn⁴⁺, Fe³⁺, and SO₄²⁻ (Michael, 2015). When the soil is highly reduced (-180 to -150 mV) under increasing periods of inundation, Fe³⁺ reduction begins. During the reduction of Fe³⁺ to Fe²⁺, P is released, but the availability of toxic Al increases, resulting in large amounts of toxic Al³⁺ being taken up with Fe by plants. The resultant Fe²⁺ has antagonistic interactions with cationic nutrients, particularly Mn, Zn, and K, leading to deficiencies. Fe²⁺ affects Mn uptake, strongly binds to Zn, re-oxidation results in plaque formation, and reduces the concentration of Zn by forming ZnFe₂O₄. The plague itself is a physical barrier to Zn and Mn uptake. The uptake of K is known to be affected by excess Fe²⁺ in the soil, similar to Zn and Mn.

3.2 Acid Sulfate Soils

An extreme case of acid soil in the humid tropics is acid sulfate soils (ASS) (Fig. 3). These soils were formed naturally within the last 10 000 years (Joukainen and Yli-Halla, 2003) after the last sea level rise (Michael, 2013) and occur under waterlogged, reducing conditions throughout the tropics. When the sea level was raised and inundated the land, sulfate in the sea water mixed with iron oxides and decomposable organic matter in the sediments, allowing sulfate-reducing bacteria to form iron sulfide minerals, predominantly pyrite (FeS₂) under the anaerobic conditions (Canfield et al., 2006). This microbially-mediated process of the iron-sulfide mineral formation using organic matter (CH₂O) as an energy source for the soil microbial ecology is shown in equation (Eqn. 1).

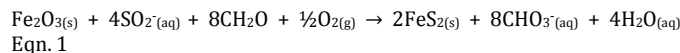

Figure 3: Global distribution of acid sulfate soils.

The global distribution of ASS is estimated to be 17 – 24 million ha, of which 6.5 million occur in Asia, 4.5 million in Africa, 3 million in Australia, 3 million in Latin America, 235 000 in Finland, and 100 000 in North America (Michael et al., 2015). The three generic types are: (i) sulfidic material and sulfidic soil horizon, may contain H₂SO₄ and also contain FeS₂, previously referred to as ‘actual’ ASS; (ii) sulfidic material, contains FeS₂ previously referred to as ‘potential’ ASS; and (iii) monosulfidic material, contains iron monosulfide (FeS) minerals that are still waterlogged, also known as monosulfidic black ooze (Ward et al., 2004a;b; Isbell, 2002; Soil Survey Staff, 2014; Soil Survey Staff, 2014). These soil materials were redefined and adopted in the 2nd Australian Soil Classification (Isbell and the National Committee for Soils and Terrain, 2015).

The sulfidic soil materials (pH>4) pose no problem under the natural water table unless the FeS₂ (Eqn. 1) is exposed by natural processes or anthropogenic activities and reacts with atmospheric O₂ and forms sulfuric (H₂SO₄) soil materials (pH<4) (Nordmyr et al., 2008; Ward et al., 2004a). There are several chemical processes through which the oxidation of FeS₂ and generation of the H₂SO₄ occur. The overall oxidation process, however, generates acidity (H⁺) in the absence of the acid-neutralizing capacity of the soil (Cook et al., 2000; Lin et al., 2000), as shown in Eqn. 2.



The presence of the H₂SO₄, in turn, dissolves the soil matrices in which iron species (Fe²⁺, Fe³⁺), Al (Al³⁺), Mn (Mn²⁺), and other toxic soil constituents (elements, metals, or metalloids) are held, releasing them into the soil-water-plant environment (Ljung et al., 2010; Ljung et al., 2009; Nordmyr et al., 2008; Roos and Astrom, 2005). Generation and propagation of H₂SO₄, mobilization, transportation, and accumulation of toxic constituents (e.g., Fe²⁺, Al³⁺) are the main processes through which ASS pose adverse environmental and ecological impacts (Michael, 2013).

3.3 Causes of Acidity

The leading cause of acidity in ASS is the oxidation of pyrite (FeS₂). Oxidation of FeS₂ formed (Eqn. 2) occurs as a result of iso-static land uplift (Wilson, 2005), drought events, and artificial drainage that lower water table (Reid and Butcher, 2011; Michael, 2013), and soil moisture alterations caused by land use and climate change (Kawahigashi et al., 2008; Michael, 2020). Other examples of potent sources of sulfidic mineral exposure and oxidation are growing water-hungry crops, constructing ditches, drains, and raised beds, excavating soil surfaces, and destroying impermeable layers. Pondered pastures, aquaculture ponds, gravel extraction, and road construction contribute to sulfidic mineral oxidation (Powell and Martens, 2005). Climate change has raised the global temperature, and a significant amount of water and soil moisture is lost yearly (Michael, 2020a, b). The change in the water table as a result of climate change is a significant reason acidity is a concern in areas where ASS are found (Fig. 3). In the humid tropics, for example, the distinct dry-wet season cycles cause seasonal variations in acid production, with more acid being produced during dry seasons and subsequent reduction during the wet season (Husson et al., 2000).

The oxidation processes and biochemical pathways that lead to the conversion of FeS₂ to ferrous iron (Fe²⁺) and sulfate (H₂SO₄) proceed in 4 steps (Lin et al., 2000). These pathways produce acid (H⁺) and Fe species as the primary source of contaminants. Firstly, FeS₂ reacts with O₂ and

water to produce Fe^{2+} , SO_4^{2-} , and acid. In this reaction, every mole of FeS_2 consumed yields 2 moles of acid (Eqn. 3).

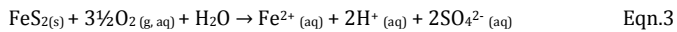

The Fe^{2+} formed in Eqn. 3 is hydrolysed to Fe^{3+} (Eqn. 4) in a slower, FeS_2 oxidation rate-determining reaction. However, when the soil pH drops to <4 , Fe^{2+} is oxidized to Fe^{3+} at a faster rate catalysed by Fe-oxidizing bacteria (*Acidithiobacillus ferroxidans*). This reaction consumes oxygen and is responsible for the deoxygenation of water systems (Bush *et al.*, 2004b). The SO_4 formed in Eqn. 3 does not further undergo oxidation, therefore, the S is not freely available.

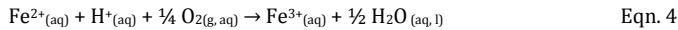

The Fe^{3+} formed in Eqn. 4 is hydrolysed with water to form solid ferric hydroxide (ferrihydrite) (Eqn. 5) and is rapid at circumneutral pH. As the pH drops to <4 , solid minerals do not form, and Fe^{3+} remains in the solution as a main contaminant source, whereas at $\text{pH}>4$, precipitates are formed instead. The Fe^{3+} in solution is highly mobile, and the precipitate, if strongly adsorbed, is immobile, affecting the fate of this soil constituent.

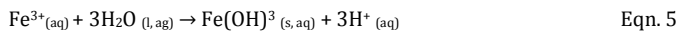

The remaining FeS_2 , if any, are hydrolysed by Fe^{3+} biochemically in a non- O_2 -dependent reaction (Eqn. 6). This reaction depends either on FeS_2 or Fe^{3+} and is cyclic and continuous. This reaction produces more acid.

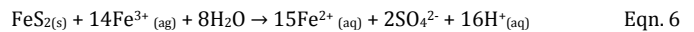

Equation 2 shows that the overall oxidation process yields 4 moles of H^+ for every mole of FeS_2 consumed. The Fe^{2+} produced in Eqn. 3 is transported up the soil by capillary rise or diffusion and makes Eqn. 4 to recur if O_2 is present. The Fe^{3+} generated in Eqn. 4, when transported down the profile to where the FeS_2 is, the Fe^{2+} developed in Eqn. 2 propagates oxidation further, even if the FeS_2 is submerged (Cook *et al.*, 2000). Secondary minerals such as jarosite, natrojarosite (pale yellow mottles and coatings), Schwertmannite (orange-yellowish coatings), sideronatrite (bright-yellow green coatings) and metavoltine (distinct golden yellowish or greenish crystals) can form if the products undergo hydrolysis reactions and store acidity (Michael, 2013).

3.4 Impacts of ASS acidity

The main impacts associated with ASS are acidification and accumulation of potentially toxic contaminants (Fältmarsch *et al.*, 2010). Under severe conditions, the acid produced lowers the soil pH to <4 if ANC is absent (Nordmyr *et al.*, 2008). This, in turn, dissolves the soil matrix in which significant constituents of the soil, as well as trace elements, are present, which get mobilized and become mobile. Based on the biochemical pathways shown (Eqns. 1 to 6) and the products of oxidation, H^+ , Fe species, and release and mobilization of toxic soil constituents, particularly Al, are the main sources of the negative impacts of ASS, e.g., shown in Fig. 4.



Figure 4: Polluted farmland drains near Murray Bridge, South Australia, with iron flocs containing dominantly Schwertmannite, formed because of the presence of ASS with sulfuric materials adjacent to the drains (Michael *et al.*, 2013).

In addition to the reduction in pH, contaminants released from soil and transported in groundwater affect food production and stock care, drinking water sources, personal hygiene, washing, and cooking (Ljung *et al.*, 2009). Aquaculture and fisheries industries are also known to be badly affected (Fitzpatrick *et al.*, 2010). Where developments disturb ASS, human exposure is prevalent (Buschmann *et al.*, 2008). Deoxygenation is a crucial ecological impact associated with the oxidation of FeS_2 , which results from bacterial oxidation of Fe^{2+} to Fe^{3+} . Acidified water sources and low oxygen levels are undesirable for most aquatic life (Cook *et al.*, 2000). Drainage containing high levels of acid and low levels of O_2 threatens most aquatic plants, inshore fisheries, and breeding grounds of marine organisms. Recent studies have indicated that secondary accumulation of Monosulfidic Black Ooze (MBOs), mainly acid volatile sulfide (AVS) of 0.01 percent, in drains leading to reef waterways has similar effects. Aquatic organisms are sensitive to water quality, and freshwater fish, aquaculture, and other aquatic services are impacted (Baldwin and Mitchell, 2012).

3.5 pH-Dependent Charge Minerals

In the tropics, most soils contain clay minerals whose surface charge is pH-dependent. These include but are not limited to crystalline and non-crystalline oxides and hydrous oxides of Al, Fe, Mn, Ti, allophane, amorphous silica, kaolinite, and halloysite. At some point, the surface charge (CEC) of these minerals and organic matter is zero, often called zero

point of charge (ZPC). Understanding the ZPC is important to manage minerals whose surface charge is pH-dependent and depends mainly on alumino-silicate clays and the amounts of free sesquioxides and organic matter. The CEC and its management are important in preventing the loss of pH-dependent charge minerals. The background on what happens to the soil matrix when the pH is low (<4.5 units) and how to charge minerals behave, that is, adsorption and precipitation. For instance, Al saturation increases as soil solution pH is <4.5 .

The availability of organic matter is affected by several factors, e.g., vegetation type and cover, and is influenced by the soil depth. Organic matter availability decreases as soil depth increases; therefore, a corresponding availability of high amounts of charge minerals occurs in deep soils, potentially causing Al, Mn, and Fe toxicity. While most land use plans concentrate on the surface soil, e.g., the top 0 – 60 cm, and the humid tropics are wet, the high rate of soil weathering, leaching of soil nutrients, destruction of the surface topsoil, and the organic matter content, removal of the rainforest and savannah grasslands and severe erosion as a result of heavy rain are other factors that attribute to the variation in the charge minerals.

Exchangeable cations equilibrium is shown in Fig. 5. Clay minerals in Ultisols are kaolinitic (soft and whitish formed by weathering of aluminium silicate) and are not easily weathered but are susceptible to erosion because of poor physical properties. In Oxisols, kaolinite and

oxides of Fe and Al dominate the clay mineralogy, and weatherable minerals, such as montmorillonite, are absent. Oxisols have excellent physical properties, low shrinking and swelling, reasonable infiltration rate and drainage, low erosion hazard, and can tolerate compaction. The surface charge of Oxisols is less than 16 meq 100 g⁻¹ of clay, of which <10 meq may be related to permanent charge.

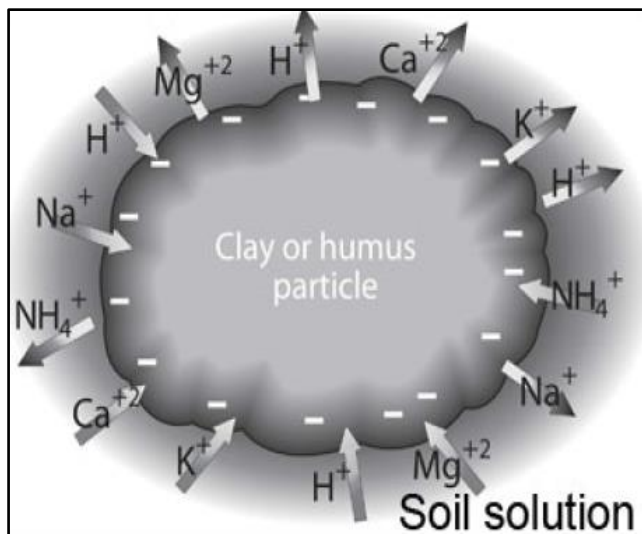

Figure 5: Exchangeable nutrient cations in equilibrium with the soil solution (Nathan, 2021, University of Missouri, USA).

Soil acidification is buffered by the dissociation of carbonates, exchangeable cation replacement by Al³⁺ and H⁺ through CEC, and dissociation of Al, Mn, and Fe-bearing minerals. In some soils, the exchange of cations becomes the primary buffering process (Fig. 5). As leaching sets in, base saturation decreases with a surge in Al availability, affecting crop growth and yield in farmlands. The buffering processes were discussed in subsections 3.1.1 and 3.2.1 (acidity, toxicity, and low nutrients).

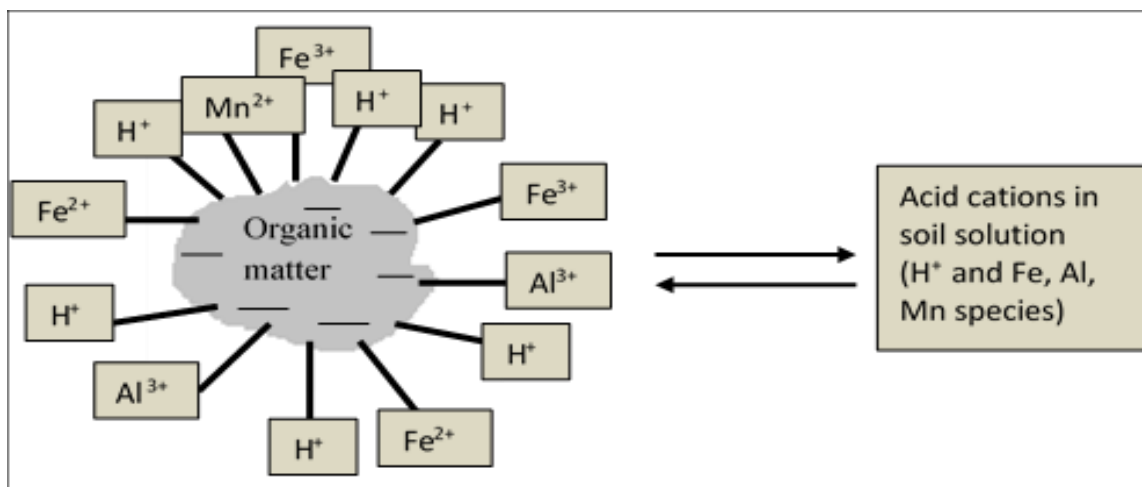

Figure 6: Adsorption of acid cations by organic matter in a soil solution. The negative charges in an organic matter are indicated by the single broken lines (—).

The exploitation of the natural forest in an unsustainable manner leads to the entire forest ecosystems being adversely affected, and degradation occurs, which depending on the severity, leads to savannah grassland. The land conversion process not only results in biodiversity loss but soil organic carbon, soil fertility, and the ecological services that sustain the natural processes. In the absence of these services, a savannah is dominated by a few shallow-rooted shrubs and grasses, predominantly cogon grass (*Imperata cylindrical*) with a very thin cover compared to the natural forest (Michael, 2018a-c).

The thin cover of the savannah grassland is not sufficient to replenish the degradation that occur during the land conversion processes of the natural forest and further leads to the soil becoming barren, which is unable to support re-establishment of any form of vegetation. The small turnover of organic matter coupled with frequent burning as a result of fire and erosion of the surface soil are the main reasons exchangeable bases (P, K, Ca, Mg), base saturation, organic carbon, CEC, microbial activity, water holding capacity, permeability and water infiltration are low, and

4. SUSTAINABLE MANAGEMENT

The general land uses of the acid soils in the humid tropics largely depend on sustainable management of the limiting soil factors. As pointed out previously, the causes of the problems of the acid soils are multiple, resulting from chemical, physical, and biological processes that are important to the general health of the soils and need to be managed simultaneously for general soil use. The soil's chemical and physical properties, such as temperature, moisture, pH, CEC, and soil nutrients, must be adequately managed in acid soil. The sustainable management practices or techniques considered need to comprise land clearing and preparation options, land conservation principles, organic matter management and use, application of a neutralizing agent such as lime, drainage, and water table management, tailored management of nutrients deficient in the soil and choice of crops to be cultivated. Management of the agro-climatic conditions that affect land use principles is crucial in acid soils. Some of these options are important to manage Oxisols, Ultisols, and ASS, as three common types of acid soils in the humid tropics (considered previously under sections 3.1 and 3.2).

4.1 Management of Soil Acidity and Infertility

4.1.1 Natural Forest Management

In the humid tropics, three main vegetation types necessary for the sustainable management of acid soils are forest, anthropic savannah, and barren land. The forest is the natural vegetation and its richness of the ground under the forest is not attributed to the parent soil materials but to the organic litter of the forest biomass. The organic litter not only adds organic carbon to the acid soil but buffers acidity, retains soil moisture, builds high nutrient capacity, creates microbial ecology (e.g., mycorrhizal fungi), and conserves nutrients that help alter the biological (Michael, 2020i), chemical, and physical properties of the acid soils, some of which have acid neutralizing capacity (Michael et al., 2016; 2017). The diverse range of forest trees, flora, and fauna provide diverse ecological services, e.g., hosting a range of microbes to decompose organic litter and recycle nutrients, mitigation of flood, drought, or erosion events, purification of water, and reduction of atmospheric greenhouse gases. The buffering processes of organic matter in the soil is shown in Fig. 6.

exchangeable and saturation percentage of Al, free Fe and Mn concentrations are high in savannah grasslands. Considerably, agriculture in savannah grassland in the humid tropics require high fertilizer input to correct the deficiencies and management of the acidity and toxicity related to Al, Fe and Mn. A plan to redevelop the savannah or a barren land needs to consider organic matter addition and supplementation of the nutrients lost (Michael, 2021a). Correcting of the changes in soil biological, chemical and physical properties made as a result of clearing, erosion and leaching or increase in soil toxicity is important for land use considerations (Bob and Michael, 2022; Michael, 2022).

4.1.2 Organic Matter Management

Some examples of organic matter are shown in Figure 7. Organic matter is vital for soil health and productivity in the humid tropics, and its management is essential to prevent the loss, significantly when the natural forest is cleared and burned, often practiced in shifting cultivation (in a small area) or in plantation agriculture (Bob and Michael, 2022). Initially,

whatever the type of organic matter is, decomposition (which consists of four main processes, Fig. 8) and mineralization provide soil nutrients (Table 1), supply cations for CEC, recycle nutrients, and increase nutrient retention and leaching of micronutrients (Michael, 2021a). Compared to the organic litter from forest trees, a range of organic matter sources from farm yard manure of livestock operations to green manure from cover crops and crop residues (estimated at 3.8 billion tonnes per year) are available (Lal, 2005). The management and use of these different types of organic matter are essential in acid soils (Michael, 2021a).

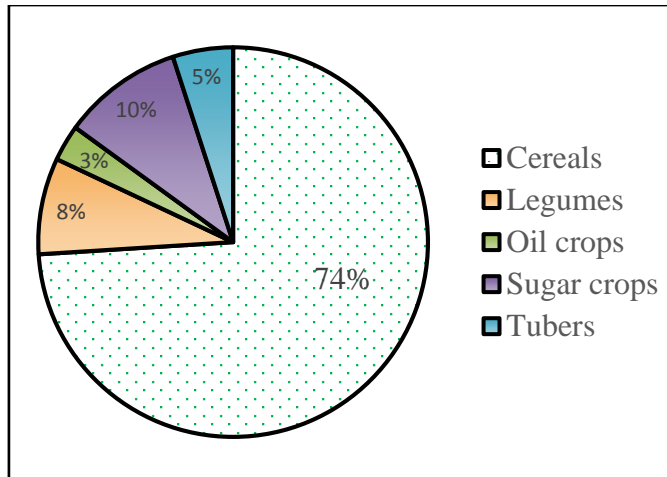

Figure 7: Global crop residue production which can be put to use (Lal, 2004).

The microbially-mediated decomposition results in considerable CO_2 evolution (Fig. 8), which dissolves in water and forms H_2CO_3 . Minimal CO_2 is held in acid soils, making it impossible for pH to decline below 5 units (Bolan et al., 2003). In a natural forest, the nutrients supplied from the decomposition of organic litter are recycled as nutrients get picked up by the trees, and organic litter continues to fall back into the soil from them, a necessary process that sustains the fertility of the soil, even in acid soils. Clearing a rain forest and burning the fallen trees or the debris results in a reduced organic litter, reduced decomposition due to microbial ecology imbalances, loss of soil moisture, and consequently, loss of soil nutrients (Michael, 2021a).

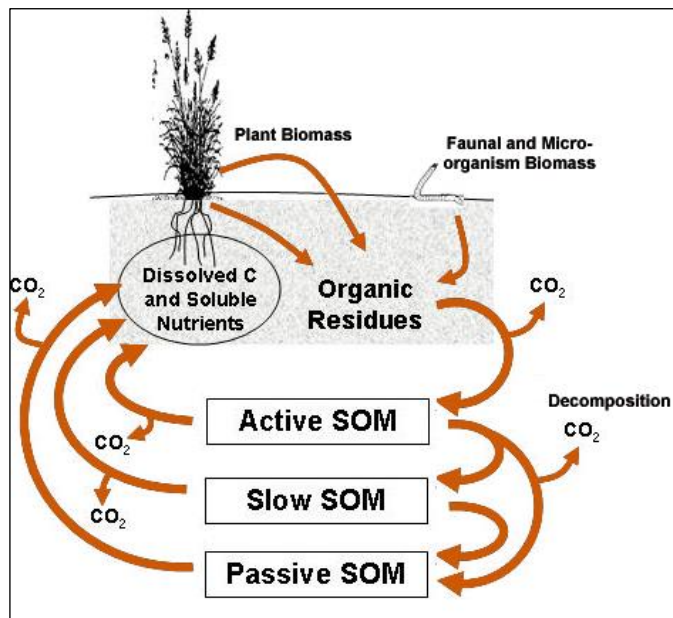

Figure 8: Microbially-mediated organic matter cycling in soil (anonymous).

In poor and highly weathered soils, e.g., in Ultisols (Acrisols), organic matter forms aggregate and improves soil physical properties. In a forest, soil temperature rarely exceeds $30\text{ }^\circ\text{C}$ and is dangerous to roots and root hairs above $34 - 42\text{ }^\circ\text{C}$. Soil organic matter management is essential, particularly under crop production, to help reduce temperature extremes by balancing radiant energy. In the humid tropics, the amount of rainfall received is high, and most crops are rainfed, but the management of soil

moisture, in general, is essential. Organic matter management is crucial in moisture retention particularly in Oxisols, where soil physical properties are good, and the free drainage is high (Michael et al., 2015). Organic matter applied on the surface reduces evaporative moisture loss, regulates temperature by providing an insulating effect, reduces weed growth, and promotes surface root concentration for efficient water utilization. For instance, in Ultisols, structural stability is poor, and surface runoff and erosion are serious land use concerns, and organic matter prevents most of these from happening.

Leaving organic matter on the surface soil or consideration of practice (minimum or zero tillage) that does not affect organic matter composition is essential to maximize the mulching effect. In situations where the forest land is cleared, management of the stumps, logs, and debris in such a manner that allows them to undergo decomposition and return to the soil is an option to manage pore space stability and distribution, which promotes water losses (Chan et al., 2003). In sandy soils, water holding capacity is poor and organic matter plays a significant role in water retention and leaching of cationic nutrients because of the negative charges available on them (Walker et al., 2004; Michael, 2020).

Organic matter and its effects on soil pH vary and depend on base cations, organic anions, C: N ratio, and the initial pH. Under general land use systems, organic matter addition increase soil pH lowers, or has no effect (Xu et al., 2006). In acid soils, for example, organic matter neutralizes acidity (H^+) and increases pH (Michael et al., 2015). The mechanism is the complexation of protons and Al by organic anions shown in Fig. 5. Decarboxylation of organic anions and release of hydroxyl groups during decomposition consume protons, causing the pH to rise. Soil microbes use H^+ as an electron acceptor and reduce its concentration during the decomposition of organic matter (Michael, 2015a; b). On the other, ammonification of residue-N, nitrification of ammonium, and leaching of nitrate lower soil pH (Xu et al., 2002). Contrarily, organic matter addition may lower alkaline pH and increase low pH. These contradicting results come from the types of organic matter used and the soil type in which the application was made (Michael, 2013). In most of our studies in ASS, we reported increase in pH following organic matter addition e.g., (Michael et al., 2015/ 2016/2017).

Table 1: Nutrient composition of selected common crop residue of the humid tropics.

Plant species	Nutrient ($\text{kg ha}^{-1} \text{ yr}^{-1}$)		
	N	P	K
Cowpea stem	1.07	1.14	2.54
Cowpea leaves	1.99	0.19	2.20
Rice	0.58	0.10	1.38
Maize	0.59	0.31	1.31
Oil palm (processed fibre)	1.24	0.10	0.36
Sesbania leaves	4.0	0.19	2.0
Crotalaria spp.	2.89	0.29	0.72
Tephrosia spp.	3.73	0.28	1.78
Water hyacinth	2.04	0.37	3.40
Azolla spp.	3.68	0.20	0.15
Typha spp.	1.37	0.21	2.38

In soils where Al, Fe, and Mn toxicity are prevalent, organic matter forms complexes by adsorption (Fig. 5), thereby decreasing the availability and toxicity of these acid cations (Michael, 2015a). High concentrations of base cations (Ca, Mg, and Na) are in plant residues and are released in the soil, having a liming effect (Tang and Rengel, 2003). In addition, organic matter carries more negative charges than the mineral component of soils and can retain cations and reduce the availability of acid cations (Fig. 5). This is why cations are not readily leached in high organic matter soil.

Microbially mediated decomposition of organic matter releases reducing substances that cause reduction reactions that consume acidity, increasing the pH e.g., (Michael et al., 2015). When significantly reduced, the reduction reactions are such that O_2 decreases initially, followed by NO_3 , oxidized Mn, and Fe (Eqns. 7 and 8). When the soil is moderately reduced ($300 - 200\text{ mV}$), facultative microbes use Mn^{4+} as an electron acceptor, and as reduction continues to $\text{Eh } 100 - 0\text{ mV}$, Fe^{3+} is reduced. Activation of Mn and Fe due to reduction reactions poses toxicity problems as plant availability increases and is a limiting factor to plant growth.



Organic matter and residue management, including reduced tillage, are essential land use practices to address acid cations toxicity and increase production (Brennan et al., 2004). Conservation tillage practices are critical for microbial ecology and biomass, microbial activity and distribution, and ecological services, which are crucial to acid soil management (Balota et al., 2003).

4.1.3 Nutrient Deficiency Management

The nutrient availability in a surface environment is pH-dependent (Fig. 9). Most nutrients, except for P, which is available at pH 6 to 8 units, are available within a pH range of 6 to 7 units, with N, K, Ca, Mg, and S in a range of 6.5 to 8 units, while B, Cu, Fe, Mn, Ni, and Zn are within a range of 5 to 7 units. The deficiency of these nutrients is associated with many acid soils, and poor growth of plants in natural vegetation or under agricultural land use is caused by acid cations (Al, Mn, and Fe) toxicity and deficiencies of P, Ca, and Mg (e.g., Rahman et al., 2018). In addition to toxicity, one common problem related directly to acidity is low soil fertility (Rahman et al., 2018). As soils become acidic, the availability of essential nutrients becomes limited, mainly because the soil matrix is dissolved and leaching losses occur as solubility increases (Fageria et al., 2007).

The maintenance of soil fertility can be achieved through soil cover, that is, vegetation management or organic matter as presented previously, or application of secondary fertilizers if soil properties are managed well. It has already been pointed out that the cationic nutrients mostly deficient in acid soils are P, Ca, and Mn (Fageria et al., 2007). However, other nutrients need equal attention. The burning of organic matter has been known to release nutrients tied up. However, loss of N, S, and P or even K through volatilization at very high temperatures is possible, and nutrient deficiency can occur where residues are burned (Sharma and Mishra, 2001).

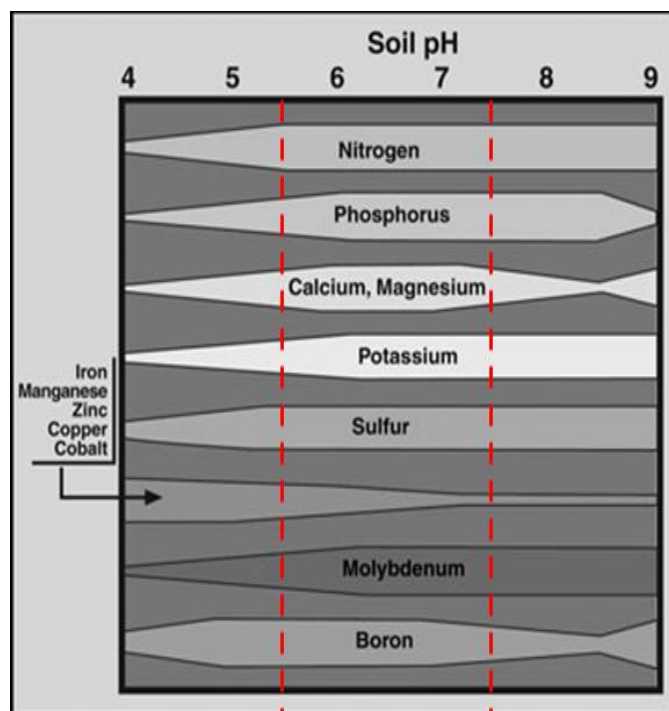

Figure 9: pH-dependent availability of essential soil nutrients (adapted from National Soil Survey Manual, USDA, NRCS, 2017). The relative availability is indicated by the width of the band. pH less than 5.5 and 7.5 units is over acidic and alkaline, respectively. Sulfuric soil pH can be less than 4.0 units.

Nitrogen: In the humid tropics, an ample supply of N is available in newly cultivated soil following a land conversion on forest land with a pH range of 5.5 to 8.0 units. As the soil pH drops below 5.0 units, the yield is always low because of acidity, toxicity, and deficiency of other nutrients, particularly P, whose bioavailability becomes limited at pH 5 units and lower. Considerable management of N in acid soil includes liming to offset the acidity and toxicity and applications of N sources to manage nutrient deficiency. Organic matter management and the use of cover crops (green manure) for the biological fixation of atmospheric N is an inexpensive

strategy. Choosing organic matter, particularly those with high N content, e.g., pea straw, is essential to manage soil acidity and improving microbial ecology (Michael et al., 2016). Free-living N-fixing microbes (e.g., *Azotobacter*) in soil and *Rhizobium* living with leguminous plants supply N to the soil. In acid soils, most microbes are known to function around a circumneutral pH, which is a problem for most of them at 5.5 units. This can be corrected by liming, which increases the pH, alleviates toxicity, and supplements deficient nutrients.

There are several N fertilizers to choose from that are available. However, the choice of suitability is essential. Urea must be incorporated into the soil or applied during the onset of rain to minimize loss through volatilization. Ammonium sulfate needs to be used with caution in soil S is required to mitigate its acidifying effects. Such precaution could include its application immediately after liming or under crops tolerant to acidity. Other N sources of practical importance are ammonium chloride and ammonium phosphate. The uses must be managed strategically to address practical issues, not only the N requirement. Transformation of different types sources of N fertilizers to NO_3^- results in more H^+ and lowers the soil pH (Guo et al., 2010). Ammonium-based fertilizers, urea, and elemental sulfur acidify the soil. Equation 9 shows the nitrification of ammonium salts.



Unless the nitrate is leached, there is no net acid because the H^+ is taken up with nitrate by crops. Similarly, acidification following urea application occurs when it is converted to NH_4^+ , is nitrified, and the NO_3^- is leached. Elemental S, when applied, is oxidized to H_2SO_4 , but SO_4^{2-} produces no acidity because it does not further undergo oxidation.

Phosphorus: The availability of P is excellent within a pH range of 6.5 and 7.5 units (Fig. 8). As such, the total and plant-available P of the acid soils of the humid tropics are low. This is a severe problem under agricultural land use, particularly for crop production. Equally important is that much of P in secondary fertilizers can be converted into non-available forms, and fixation can occur. Phosphorus fixation is high in weathered soil of low Ca content and high amorphous oxides of Al and Fe with increasing clay content. The complex P compounds of Al and Fe are either strongly precipitated or adsorbed, and the loss of availability is permanent.

The P fixation process is affected by pH <5.5 units, Al and Fe oxides, crystalline and lattice minerals (gibbsite, goethite, kaolinite, and montmorillonite) contents, and soil moisture. The intensity of P fixation by different types of minerals is such that amorphous oxides > crystalline oxides > 1:1 clay > 2:1 clay. Al-P complexes are more pronounced in wet soils, whereas under dry soil conditions, less soluble Fe-P predominate. The P fixation process is affected by pH <5.5 units, Al and Fe oxides, crystalline and lattice minerals (gibbsite, goethite, kaolinite, and montmorillonite) contents, and soil moisture, respectively. The intensity of P fixation by different types of minerals is such that amorphous oxides > crystalline oxides > 1:1 clay > 2:1 clay. Al-P complexes are more pronounced in wet soils, whereas under dry soil conditions, less soluble Fe-P predominate.

To manage the deficiency of P, several options are available. The importance of working with organic matter concerning soil fertility management has been discussed. Several P fertilizers that are either water or acid soluble are available but must be suitable for acid soils to realize the benefits. Finely ground rock phosphate, being water soluble, is an excellent source of P and Ca. It contains up to 50% CaO and can increase the available Ca, increases soil pH, and lower exchangeable Al content. Basic slag and fused magnesium phosphate are known as P and Ca, and the application methods must be carefully considered to maximize their uses. The water-soluble P fertilizers that can be sourced are single and triple superphosphate and mono- and diammonium phosphates. In P fixing soils, the soil contact must be reduced to avoid reaction with Al and Fe to prevent fixation.

Potassium: In most soils, K availability becomes limited as pH drops below 4.5 units and almost above 6 units (Fig. 8). Sulfur has a similar fate with K. K deficiency is much more pronounced in farm soil where crop residue removal is high. In acid soils, weathering and leaching of K from soil minerals is high, particularly in 1:1-layer silicate clays (e.g., kaolinite), which do not fix K. Liming an acid soil prevents leaching and supplements Ca as it increases the CEC activity. As the pH is raised, more K is absorbed by plants, and nutrient deficiency may occur, and the application of K-source fertilizers needs to be made. The availability of cationic Ca^{2+} influences K uptake, and too much of it suppresses absorption. The widely available K sources in the tropics are potassium chloride (muriate of potash) and potassium sulfate. These sources are essential for S and Cl in

deficient soil, e.g., in oil palm plantations where S is a critical component in fruit initiation and development. A small amount of K may be prevented from leaching because of its affinity to bond with Cl⁻.

Magnesium: In highly weathered acid soils (e.g., Oxisols) of pH 5.5 units and lower, Mg is highly leached and leads to deficiency unless corrected to pH 6.0 units and higher. Mg deficiency can further be complicated by Al toxicity, and applying Mg fertilizers corrects both the deficiency and Al toxicity. Dolomitic limestone is widely advisable to be used; however, where its availability is an issue, magnesium sulfate can be used instead, together with P fertilizers, to increase the CEC of the soil. The availability of Fe, Mn, B, Cu, Zn, and Mo is optimum at a pH range of 5 – 7 units (Fig. 8). Specifically, Fe > 6, Mn 5 – 6.5, B, Cu, and Zn 5 – 7 and Mo > 7 units (Fig. 8).

4.1.4 Liming To Manage Acidity, Toxicity And Nutrient Deficiency

Liming is the most common and oldest practical method used to manage the acidity and toxicity of charged minerals particularly Al and Mn. The carbonate equivalent of some common liming materials is shown in Table 2 (Fageria and Baligar, 2008). Under most beneficial conditions, the lime application is made to bring the pH of the acid soil to within a range of 6.5 to 7.0 units (Yang et al., 2018). The efficacy of lime application to manage acidity and toxicity is affected by several factors (Li et al., 2019). Acid soils in the temperate region are dominated by 2:1 silicate layer clay mineral with permanent charges, and liming effectively manages the acidity and toxicity of Al and Mn. In the tropical regions, liming is a problem because the soils are dominated by low CEC, 1:1 silicate-layer clays, and oxides of Al and Fe with high surface charges. In these types of soils, more lime is required to create surface charges, and the amount required can be very high, for instance, in clayey Oxisols (Ferralsols) and Ultisols (Acrisols).

Table 2: Carbonate equivalent of some common liming materials.		
Source	Chemical formula	Equivalent (% CaCO ₃)
Calcitic limestone	CaCO ₃	90-100
Dolomitic limestone	CaCO ₃ + MgCO ₃	95-110
Oxide/burned lime	CaO	150-175
Hydrated lime	Ca(OH) ₂	120-135
Ground shells	CaCO ₃	80-95
Basic slag	CaSiO ₃	50-80
Wood ashes	Oxides and hydroxides	30-70

Application of too much lime can lead to the creation of too many negative charges, which in turn attracts cations, such as Ca, K, Mn, Zn, Fe, Mg, and B, and lead to deficiencies. Although the weaknesses can be corrected by applying ammonium sulfate or potassium chloride, nutrient imbalances can occur. As much as lime application consumes acidity from charged acid minerals and protons, detoxification of Al, Mn, and Fe toxicity is what most agronomists seek to address the constraints of crop and pasture production. As pointed out earlier, Al and Fe form complexes with P that are insoluble or slowly soluble, making P unavailable to plants. Liming the acid soil to pH 5.5 to 6.0 units increases P availability; however, over-liming to pH 7.0 units leads to precipitation and the unavailability of cations. Liming increases CEC, especially in clayey minerals with pH-dependent charges, and prevents caching (NH₄⁺, Ca²⁺, Mg²⁺, and K⁺) leaching. Liming in oxidic soil can result in flocculation, where the surface charge can change from positive to zero, or lead to dispersion, where surface charges vary from zero to negative.

The liming material requirement is determined using a buffer to measure acidity that has to be neutralized to reach a desirable pH (Zingore et al., 2015). A suitable liming material needs to reduce the charged minerals and the proton. The most common liming materials available to manage acidity and toxicity are shown in Table 2. Burnt lime (CaO) is the most neutralizing agent available and is quite expensive when required in large quantities. Calcium oxide is the second most neutralizing agent but suffers from the cost and unavailability in many regions. The most common liming source is calcium carbonate which has an acid-neutralizing value of 100%. Limestone with equal proportions of Ca and Mg is dolomite, and with other proportions is often known as dolomitic. The acid-neutralizing value for dolomitic limestone is 95 to 100%. In finely ground form, CaSiO₃ has an acid-neutralizing value similar to CaCO₃ and is a Si source in acid soils.

Whatever kind of a lime source is added; the process of neutralizing acidity is the same. Lime sources in the form of CaCO₃, MgCO₃, CaOH, MgOH and CaO supply a lot of cations when applied in the soil (Tabitha et al., 2008).

As shown in Eqn. 10, when these compounds dissolve in the soil solution, the carbonates (CaCO₃²⁻), hydroxyl (OH⁻), and oxides (O₂⁻) react with acid (H⁺) to form carbonic acid (H₂CO₃) or water (H₂O). Since the H⁺ is removed from the soil solution, free Al³⁺ reacts with OH⁻ ions to form insoluble compounds. The process continues until all the acidic cations and CO₃²⁻, OH⁻ and O₂⁻ in the soil solution are exhausted. Consequently, carbonic acid dissociates to form water and carbon dioxide, and any excess H⁺ is converted into water. As all the active acidity are neutralized, the free cation released from the reaction of the lime source replaces the H⁺ and Al³⁺ from the exchange sites, leaving a neutral clay, water, CO₂ and Al₂O₃.



The ability of the liming material to neutralize acidity depends on the percentage of Ca²⁺, Mg²⁺ and the impurities. As pointed out, for example, pure calcium carbonate has a 100% total acid-neutralizing value. As the liming material is sold on a weight basis, estimation of the water content is essential to determine the actual content.

4.2 Management of ASS

Acidification of ASS is severe when acid neutralizing capacity (ANC) is low, and acid production exceeds the environment's ability to neutralize it. Therefore, the measurement of the ANC is essential (Ahern et al., 2004). When carbonate sources, e.g., shell fragments, are present, acidity is neutralized, and oxidation of Fe²⁺ to Fe³⁺ proceeds slowly (Fitzpatrick et al., 2008). In ASS containing H₂SO₄, the product of FeS₂ oxidation forms sulfate-rich salts (e.g., epsomite and hexahydrate) due to evaporation. The chemical reaction that neutralizes the acid when a liming agent is present is shown in Eqn. 11.

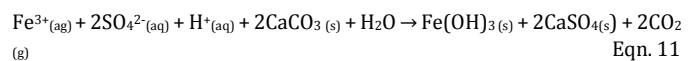

The impacts of acidified soil and water systems and toxic element leachates have become important issues in ASS environment and various management strategies have been proposed and tested (Ahern et al., 2004; Vegas-Villarrubia et al., 2008). These include 1 minimizing the disturbance of sulfidic soil material and maintenance of the natural water table to prevent and slow the extent of pyrite oxidation and 2 neutralization of actual acidity by application of a liming agent such as an agricultural lime, and management of acidic water discharge and toxic by-product leachate (Dear et al., 2002; Ward et al., 2004b). Considerable management options include mitigation and rehabilitation, retaining existing acidity, and leachate discharge management (Cook and Gardner, 2001).

As pointed out in the management of Oxisols and Ultisols previously, the application of an ameliorant such as hydrated lime (Ca(OH)₂) or limestone (mainly CaCO₃) has been pointed out by several researchers to manage sulfuric soil (Baldwin and Fraser, 2009). Liming, however, is costly due to its more comprehensive ASS presence (Fig. 2) and may be ineffective when its occurrence is in deeper soil layers with high clay content or becomes coated with minerals, e.g., gypsum and Fe (Hammarstron et al., 2003). Many studies have shown that organic matter addition can ameliorate both ASS types (Baldwin and Fraser, 2009; Reid and Butcher, 2011; Michael et al., 2015; 2016; 2017). The principle behind this is that organic matter addition and decomposition create a micro-environment sufficient to consume O₂ due to aerobic microbial respiration and reduce the availability of Fe³⁺ by complexation and coating of FeS₂.

Table 3 shows a number of studies we did that showed organic matter addition is sufficient to manage both ASS types under varying moisture regimes when laid on the surface as mulch or incorporated by working into the soils. The efficacy of the organic matter, however, is dependent on nitrogen content. For instance, the effect of lucerne hay with more nitrogen was reasonably practical compared to wheat straw with a lesser range of the same nutrient (Table 3). The data shown indicated that the results were pronounced more when organic matter was incorporated in the ASS than when laid on the surface as mulch (Table 3). This point out that the efficacy of the organic matter depends on the microbial ecology established and the microbes' ability to modify the soil chemistry (Michael 2018c). So, for the organic matter with a high N content, this nutrient is a requirement for the growth of soil microbes, which supports the creation of the type of microbial ecology conducive to induce changes in soil chemistry.

Table 3. Ameliorative effects of organic matter amendment in ASS pH.

Amendment type	Application method	ASS type	Moisture condition	Initial pH	Final pH	Reference
<i>Phragmites</i> leaf	Incorporated	Sulfuric	Aerobic	3.7	7.6	Michael <i>et al.</i> (2015)
<i>Phragmites</i> leaf	Overlaid	Sulfuric	Aerobic	3.7	5.0	Michael <i>et al.</i> (2015)
Wheat straw	Incorporated	Sulfuric	Aerobic	3.7	5.9	Michael <i>et al.</i> (2016)
Lucerne hay	Incorporated	Sulfidic	Aerobic	6.7	7.9	Michael <i>et al.</i> (2016)
Wheat straw	Incorporated	Sulfidic	Aerobic	6.7	5.5	Michael <i>et al.</i> (2016).

The nitrogen content of *Phragmites* leaf, lucerne hay, and wheat straw was 3.7%, 3.2% and 0.8%, respectively (Michael *et al.*, 2017).

In both types of ASS, the data presented in Table 3 show the application method of organic matter is essential. Incorporation of the organic matter in the soil by bulk mixing, as would be under normal land use conditions, such as in farms, was more promising. Under an aerobic soil condition, a sulfuric soil material is expected to remain acidic, and a sulfidic soil material acidify as pyritic minerals are exposed and oxidized. These expectations did not happen when organic matter was incorporated compared to the organic matter overlaid on the surface. Incorporating organic matter of high nitrogen content increased the sulfuric soil pH by nearly 4.0 units and that of the sulfidic soil by 1.2 units, respectively. The changes in pH measured when organic matter was applied were proportionate to the nitrogen content. In other related studies the moisture content of the different types of ASS was important (Michael, 2017). In both ASS types, no changes in pH were measured between a field capacity of 0-50%, whether a 10% residual organic matter was in the soil or organic matter amendment was made (Michael, 2017). When the soil moisture content was maintained at 100% field capacity, the changes in pH and sulfate contents measured were small, indicating that aerobic microbial decomposition of organic matter is necessary for the release of the ameliorants to be effective in neutralizing acidity and denial of acidification of the sulfidic soil materials.

5. FUTURE RESEARCH DIRECTIONS

In all the acid soil types considered, the three main problems associated are, in general, acidity, toxicity, and deficiency of nutrients, indicating the issues are multifaceted and therefore require tailored and systematic management (Agegnehu and Amede, 2017). These three significant problem soils call for more advance research in soil acidity management, restoration, and nutrient management (Tully *et al.*, 2015). Some research that needs to be conducted must be location-specific in the humid tropics, and others may be broad and widely regional. Consequently, research on the management of acid soils must be tailored towards important stakeholders - small farmers, land managers, and curators, or simply controlling the acid environment for general protection and use (Agegnehu *et al.*, 2014). The three main issues of acid soils in the humid tropics show that researchers must focus on several topics in some areas associated with important acid soils. These areas, in general, are the farms, the general environment (Agoume and Birang, 2009), and the site-specific regions needing special attention or consideration, such as protected areas and Ramsar wetlands. Management of these areas is crucial as leaching of cations under high rainfall followed by accumulation are the main reasons soils in the humid tropics go acid naturally.

5.1 On Farm

The farm research needs to focus on how acid in the farm can be managed for the benefit of the farmers (Agegnehu *et al.*, 2021). The application of lime has been pointed out, but in many economies, lime is expensive, and affordability is an issue (Foley *et al.*, 2011; Goulding, 2016). Therefore, systematic approaches towards introducing acid-tolerant crop varieties, pasture, or folder crops are needed for management (de Sant-Anna de Sant-Anna *et al.*, 2017). Application of organic matter, not only in Oxisols and Ultisols but in ASS, is gaining popularity, and research on how well farmers can source and use it is a vital strategy yet to be established (Haynes and Mokolobate, 2001). The local knowledge that organic matter addition addresses nutrient deficiency needs to be rejoined to say it ameliorates acidity and detoxifies toxicity (Haile and Boke, 2011). There is a need to establish which organic matter sources are readily available and relatively cheap that are locality-specific to farmers (Agegnehu *et al.*, 2014).

We have shown in several recent studies conducted in the Adelaide area in Australia that the use of dried leaves of *Phragmites australis*, a weed in managed areas, as mulch, ameliorates sulfuric soil acidity and prevents oxidation of sulfidic soil (Michael *et al.*, 2015, 2016, 2017). These types of results need to be made available to farmers so an informed choice on

what kind of organic matter source to choose, compared to the relatively expensive plant materials, such as lucerne hay and pea straw, which are commercially available. Research on the method of organic matter application, incorporation in the soil by bulk mixing versus application on the surface as surface mulch and under different moisture regimes, needs to be completed. We have, again, worked in ASS, and the incorporation of organic matter is more effective in ameliorating ASS under either aerobic (75% field capacity) or anaerobic (flooded, 100% saturation capacity) soil conditions (Michael *et al.*, 2016).

There is evidence in the literature that introducing of acid-tolerant varieties of crops, pasture, or fodder crops in acid soil is essential for a particular type of agroecosystem and a tailored approach to managing soil acidity (Wang *et al.*, 2006; Halimi, 2011). The essence is not only the crops' ability to withstand the stresses but the contributions made towards acid management from the various ecological services provided (return of leaf litter and root exudates to the soil, establishment of specific microbial ecology, cycling of nutrients and moisture retention, to name a few). The mechanism for plants to survive under acidity and high toxic levels is either tolerance or hyperaccumulation. While tolerant plants are of minor concern, accumulating harmful elements in harvestable parts of hyperaccumulator crops concerns human and livestock health.

Research on when to grow a particular type of crop is needed. For instance, research on hyper accumulator annual or perennial crops being rotated with less tolerant crops or mixed or intercropping with susceptible crops with hyper accumulator annuals. The approach must include practices such as relay and strip cropping so that the annual accumulator is harvested first than the crop (Agegnehu and Amede, 2017). The harvested materials of the hyperaccumulator can be incinerated (pyrolysis) at high temperatures and returned to the soil as biochar, which is essential to manage the acid and the return of cations and carbon back to the soil. Several recent studies showed biochar application increased the pH and Ca levels while reducing Al toxicity (Lehmann *et al.*, 2003; Steiner, 2007).

5.2 General environment

In the general environment and protected areas, applying a liming agent is expensive due to the large quantity required and the prohibition put in place. In marshlands and wetlands, the conditions of the environment, e.g., the presence of surface water, make it simply impossible to apply. In such places, conservation of the natural vegetation is a critical approach to ensure the natural processes manage the soil acidity, toxicity, and nutrient deficiency status. This approach is vital for mesoscopic as well as surface water benthic organisms. One of the problems that have begun to get the attention of land use managers and environmental conservationists alike recently is the management of an environment that has undergone drying and lost inundation due to drought, climate change, or land use. Under such situations, the area that has undergone drying is significant, and most of the considerable losses in aquatic plants and animals occur due to acidity, toxicity, or simply the loss of their marine habitat, and recolonization of the barren land is often long. The problem becomes a long-term concern, mainly when potential colonizer plants or animals are far away for seeding or settling in early. This has become a significant concern in many region acid soils are present, and research is needed to address how well reclamation or revegetation can be done if reflooding is difficult.

A recent study showed the application of sandy loam soil followed by revegetation is possible for the reclamation of barren land (Michael, 2016). We have pointed out that wetlands or marshland plants accelerate or worsen the drying conditions of ASS due to the evaporative water losses (Michael *et al.*, 2016). Researches need to be conducted on how best thirsty plants or plants containing parenchymatous tissues capable of pumping oxygen into their rhizosphere and oxygenate deep soil are required. This research is essential, especially in the sulfidic soil of ASS, where rhizosphere oxygenation can lead to acidification. Among the options available to manage such plants, slashing them down and leaving the chopped materials on the dry surface as mulch or incorporating them in the soil is more promising (Michael and Reid, 2018). On a large area,

liming agents can be broadcasted aerially; the efficacy of such is yet to be established in places where affordability is not an issue.

In the poor economies, more user-friendly and sustainable approaches are required, one of which is the application of organic matter or revegetation, and research is gaining momentum in many areas in the humid tropic, such as Indonesia, Thailand, and Malaysia as well as in Australia, particularly in ASS management. In line with the revegetation of acid-scalded surface land, the research gap on the types of plant species that can be used widely is limited to a few places. Early research has established several plant species that can be used, but most cannot be used for purposes other than reclamation. Search for plant species that can be found as plantation is needed, such as a commercial benefit and management of soil acidity realized; that is an integrated approach to addressing the problems of acidity, toxicity, and nutrient deficiency.

Some species of crop plants that can grow on a pH range of 4.5 – 6.5 units include cabbage, wheat, chicken pea, soybean, and sugarcane. The use of these types of plants to reclaim acid soil is not widely practiced in the humid tropics. Upland rice, mango, cassava, citrus, and pineapple are other crops acid tolerant to soil pH ranges between 4.0 – 5.0 units and need to be promoted.

6. CONCLUSIONS

Sustainable acid soil management in the humid tropics of high rainfall and temperature is vital to sustainable agriculture and environmental sustainability. Sustainable acid soil management is essential to address acidity, toxicity, and low nutrient availability being the significant issues of acid soils. These issues also affect soil properties, biological activity, and physical conditions. Soil acidity and toxicity pertain to high levels of protons and cationic acid minerals, particularly Al, Fe, and Mn, resulting in the low availability of essential nutrients. The practice to manage the issues of acid soils is to apply a neutralizing agent, e.g., in principle, lime. The correct use and application of the liming agents and an appropriate fertilizer application strategy ameliorate acidity, detoxify toxicity, and add sufficient amount of nutrients to the soil. In some areas in the humid tropics, the affordability of liming agents or organic-inorganic fertilizers is limited. Where affordability of liming agents and fertilizers is an issue, an integrated approach to acid soil management is required. Integrated soil fertility management approaches include but are not limited to forest cover management, organic matter application, and sustainable farming practices. Under farm conditions, introducing acid-tolerant crop varieties to cope with acidity and acid minerals and legumes to improve soil productivity are practically significant. The overarching strategy to sustainability manage acid soils in the humid tropics needs to emphasize research integrating soil, organic matter, and water management with tolerant and high-yielding crops that are agriculturally and environmentally sustainable.

CONTRIBUTIONS

This paper has been solely written by the author.

CONFLICT OF INTEREST

The author declares no conflict on interest in publication of this paper.

REFERENCES

- Agegnehu, G., Amede, T., 2017. Integrated soil fertility and plant nutrient management in tropical agro-ecosystems: A review. *Pedosphere*. 27, Pp. 662–680.
- Agegnehu, G., Amede, T., Erkossa, T., et al., 2021. Extent and management of acid soils for sustainable crop production system in the tropical agroecosystems: a review. *Acta Agric. Scand. B Soil Plant Sci.* 71, Pp. 852-869.
- Agegnehu, G., Vanbeek, C., Bird, M., 2014. Influence of integrated soil fertility management in wheat and tef productivity and soil chemical properties in the highland tropical environment. *J Soil Sci Plant Nutr.* 14, Pp. 532–545.
- Agoumé, V., Birang, A., 2009. Impact of land-use systems on some physical and chemical soil properties of an oxisol in the humid forest zone of southern Cameroon. *Tropicicultura*. 27, Pp. 15–20.
- Ahern, C.R., McElnea, A. E., Sullivan, L.A., 2004. Acid Sulfate Soils Laboratory Methods Guidelines. Department of Natural Resources, Mines and Energy, Indooroopilly, Queensland, Australia.
- Baldwin, D.S., Fraser, M., 2009. Rehabilitation options for inland waterways impacted by sulfidic sediments – A synthesis. *J. Environ. Manage.* 91, Pp. 311-319.
- Baldwin, D.S., Mitchell, A., 2012. Impact of sulfate pollution on anaerobic biogeochemical cycles in a wetland sediment. *Water Res.* 46, 965-974.
- Balota, E. L., Colozzi-Filho, A., Andrade, D. S., Dick, R. P., 2003. Microbial biomass in soils under and crop rotation systems. *Biol. Fertil. Soils*. 38, Pp. 15–20
- Becker, M., Asch, F., 2005. Iron toxicity in rice—conditions and management concepts. *Plant Nutr. Soil Sci.* 168, Pp. 558–573.
- Bolan, N. S., Hedley, M. J., 2003. Role of carbon, nitrogen and sulfur cycles in soil acidification, in: Rengel, Z. (ed.), *Handbook of acidity*. Marcel Dekker, New York, pp. Pp. 29–52.
- Brennan, R. F., Bolland, M. D. A., Bowden, J. W., 2004. Potassium deficiency, and molybdenum deficiency and aluminium toxicity due to soil acidification, have become problems for cropping sandy soils in south-western Australia. *Aust. J. Exp. Agric.* 44, Pp. 1031–1039.
- Buschmann, J., Berg, M., Stengel, C., Winkel, L., Sampson, M. L., Tang, P. T., Viet, P. H., 2008. Contamination of drinking water resources in the Mekong delta plains: arsenic and other trace metals pose serious health risks to population. *Environ. Int.* 34, Pp. 756-764.
- Canfield, D. E., Olesen, C. A., Cox, R. P., 2006. Temperature and its control of isotope fractionation by sulfate-reducing bacterium. *Geochim. Cosmochim. Acta.* 70, Pp. 548-561.
- Chan, K. Y., Heenan, D. P., So, H. B., 2003. Sequestration of carbon and changes in soil quality under conservation tillage on light-textured soils in Australia: a review. *Aust. J. Exp. Agric.* 43, Pp. 325–334.
- Cook, F. J., Hicks, W., Gardner, E. A., Carlin, G. D., Froggatt, D. W., 2000. Export of acidity in drainage water from acid sulphate soils. *Mar. Pollut. Bull.* 41, Pp. 319-326.
- de Sant-Anna, S. A., Jantalia, C. P., Sá, J. M., Vilela, L., Marchão, R. L., Alves, B. J., Urquiaga, S., Boddey, R. M., 2017. Changes in soil organic carbon during 22 years of pastures, cropping or integrated crop/livestock systems in the Brazilian cerrado. *Nutri. Cycl. Agroecosyst.* 108, Pp. 101-120.
- Dear, S. E., Moore, N.G., Dobos, S.K., Watling, K.M., Ahern, C.R., 2002. Soil Management Guidelines, Queensland Acid Sulfate Soil Technical Manual (version 3.8). Department of Natural Resources and Mines, Indooroopilly, Queensland.
- Fageria, N. K., Nascente, A. S., 2014. Management of soil acidity of South American soils for sustainable crop production. *Adv. Agron.* 128, Pp. 221–275.
- Fageria, N., Baligar, V., 2008. Ameliorating soil acidity of tropical oxisols by liming for sustainable crop production. *Adv. Agron.* 99, Pp. 345–399.
- Fageria, N., Baligar, V., Zobel, R., 2007. Yield, nutrient uptake, and soil chemical properties as influenced by liming and boron application in common bean in a no-tillage system. *Commun. Soil Sci. Plant Anal.* 38, Pp. 1637–1653.
- Fältmarsch, R., Österholm, P., Jacks, G., 2010. Chemical composition of cabbage (*Brassica oleracea* L. var. capitata) grown on acid sulfate soils. *J. Plant Nut. Soil Sci.* 173, Pp. 423-433.
- Fitzpatrick, R., Powell, B., Marvanek, S., 2008. Atlas of Australian acid sulfate soils, in: Fitzpatrick, R. W., Paul, P. (Eds.), *Inland Acid Sulfate Soil Systems Across Australia*. CRC LEME, Perth, Australia, Pp. 75-89.
- Foley, J. A., Ramankutty, N., Brauman, K. A., Cassidy, E. S., Gerber, J. S., Johnston, M., et al., 2011. Solutions for a cultivated planet. *Nature*. 478, Pp. 337–342.
- Goulding, K., 2016. Soil acidification and the importance of liming agricultural soils with particular reference to the United Kingdom. *Soil Use Manage.* 32, Pp. 390–399.
- Guo, J. H., Liu, X. J., Zhang, Y., Shen, J. L., Han, W. X., Zhang, W. F., Christie, P., Goulding, K. W. T., Vitousek, P. M., Zhang, F. S., 2010. Significant acidification in major Chinese croplands. *Sci.* 327, Pp. 1008-1010.

- Haile, W., Boke, S., 2011. Response of Irish potato (*Solanum tuberosum*) to the application of potassium at acidic soils of chench, southern Ethiopia. *Int. J. Agric. Biol.* 13, Pp. 595–598.
- Halimi, E. S., 2011. Development of acid-soil tolerant corn (*Zea mays* L.) with high-quality protein. *Agrivita*. 33, Pp. 127–132.
- Haynes, R., Mokolobate, M., 2001. Amelioration of Al toxicity and P deficiency in acid soils by additions of organic residues: a critical review of the phenomenon and the mechanisms involved. *Nutri. Cycl. Agroecosyst.* 59, Pp. 47–63.
- Husson, O., Phung, M.T., van Mensvoort, M. E. F., 2000. Soil and water indicators for optimal practices when reclaiming acid sulphate soils in the plain of reeds, Vietnam. *Agric. Water Manage.* 45, 127-143.
- Isbell, R. F., 2002. The Australian soil classification, 4. CSIRO Publishing, CSIRO, Collingwood, Victoria, Australia.
- IUSS Working Group., 2015. World reference base for soil resources 2014, update 2015: International soil classification system for naming soils and creating legends for soil maps. World soil resources reports no. 106. FAO, Rome.
- Job, J., Michael, P. S., 2022. Nutrient dynamics under unmanaged rubber, cocoa, and oil palm plantations in a sandy soil under humid lowland tropical climatic conditions. *Int. J. Environ.* 11, 46-61.
- Joukainen, S., Yli-Halla, M., 2003. Environmental impacts and acid loads from deep sulfidic layers of two well-drained acid sulfate soils in western Finland. *Agric. Ecosyst. Environ.* 95, 297-309.
- Kawahigashi, M., Do, N.M., Nguyen, V.B., Sumida, H., 2008. Effect of land developmental process on soil solution chemistry in acid sulfate soils distributed in the Mekong Delta, Vietnam. *Soil Sci. Plant Nut.* 54, 342-352.
- Kirk, G. J. D., 2004. The Biogeochemistry of Submerged Soils. John Wiley and Sons, Chichester, UK, pp. 291.
- Lal, R., 2005. World crop residues production and implications of its use as a biofuel. *Environ. Int.* 31, 575–584
- Lehmann, J., da Silva, J. P., Steiner, C., Nehls, T., Zech, W., Glaser, B. 2003. Nutrient availability and leaching in an archaeological Anthrosol and a Ferralsol of the Central Amazon basin: fertilizer, manure and charcoal amendments. *Plant Soil.* 249, 343-357.
- Li, Y., Cui, S., Chang, S. X., Zhang, Q., 2019. Liming effects on soil pH and crop yield depend on lime material type, application method and rate, and crop species: a global meta-analysis. *J. Soils Sed.* 19:1393–1406.
- Lin, C., O'Brien, K., Lancaster, G., Sullivan, L. A., McConchie, D., 2000. An improved analytical procedure for determination of total actual acidity (TAA) in acid sulfate soils. *Sci. Tot. Environ.* 262, 57-61.
- Ljung, K., Maley, F., Cook, A., 2010. Canal estate development in an acid sulfate soil-Implications for human metal exposure. *Landsc. Urban Plan.* 97, 123-131.
- Ljung, K., Maley, F., Cook, A., Weinstein, P., 2009. Acid sulphate soils and human health-A millenium ecosystem assessment. *Environ. Int.* 25, 1234-1242.
- Michael, C., 2000. Soil acidity and liming. Part 4. Auburn University, Alabama Cooperative Extension System, USA.
- Michael, P. S., 2013. Ecological impacts and management of acid sulphate soil: A review. *Asian J. Water Environ. Pollut.* 10, 13-24.
- Michael, P. S., 2015a. Effects of organic matter amendments and plants on the chemistry of acid sulfate soils under aerobic and anaerobic conditions. *J. Proc. R. Soc. New South Wales.* 148, 185-186.
- Michael, P. S., 2015b. Effects of alkaline sandy loam on sulfuric soil acidity and sulfidic soil oxidation. *Int. J. Environ.* 4, 42-54.
- Michael, P. S., 2018a. Effects of live plants and dead plant matter on the stability of pH, redox potential and sulfate content of sulfuric soil neutralized by addition of alkaline sandy loam. *Malaysian J. Soil Sci.* 22, 1-18.
- Michael, P. S., 2018b. The role of surface soil carbon and nitrogen in regulating surface soil pH and redox potential of sulfidic soil of acid sulfate soils. *Pertanika J. Trop. Agric. Sci.* 41,1627-1642.
- Michael, P. S., 2018c. Comparative analysis of the ameliorative effects of soil carbon and nitrogen amendment on surface and subsurface soil pH, Eh and sulfate content of acid sulfate soils. *Eurasian Soil Sci.* 51,1181-1190.
- Michael, P. S., 2020a. Soil fertility status and sweet potato cultivation in composted mounds under humid lowland tropical climatic conditions. *Sains Tana J. Soil Sci. Agroclimatol.* 17,144-151.
- Michael, P. S., 2020b. Organic carbon and nitrogen amendment prevents oxidation of sulfidic soil of acid sulfate soils under aerobic conditions. *Eurasian Soil Sci.* 53, 1743-1751.
- Michael, P. S., 2020c. Plants with modified anatomical structures capable of oxygenating the rhizosphere are threats to sulfidic soils under varying soil moisture regimes. *Asian J. Agric.* 4, 87-94.
- Michael, P. S., 2020d. Agriculture versus climate change – narrow staple-based subsistence agriculture is a threat to rural livelihood under climate change. *Sains Tana J. Soil Sci. Agroclimatol.* 17, 78-93.
- Michael, P. S., 2020e. Cogon grass biochar amendment and *Panicum coloratum* planting improve selected properties of sandy soil under humid lowland tropical climatic conditions. *Biochar.* 2, 489-502.
- Michael, P. S., 2020f. Simple carbon and organic matter addition in acid sulfate soils and time-dependent changes in pH and redox under varying moisture regimes. *Asian J. Agric.* 4, 23-29.
- Michael, P. S., 2020g. Effects of organic matter and live plants on sulfidic soil pH, redox and sulfate content under flooded conditions. *Bulg. J. Soil Sci.* 5, 34-49.
- Michael, P. S., 2020h. Co-existence of organic matter and live plant macrophytes under flooded soil conditions acidify sulfidic soil of acid sulfate soils. *Trop. Plant Res.* 7, 20-29.
- Michael, P. S., 2020i. Management implication of acid sulfate soil under aerobic and anaerobic soil conditions revolves around organic matter and live plant macrophytes. *Annal. Trop. Res.* 41, 1-22.
- Michael, P. S., 2021. The positive and negative effects of addition of organic carbon and nitrogen for management of sulfuric soil acidity under general soil use conditions. *Polish J. Soil Sci.* 54, 71-87.
- Michael, P. S., 2021a. Role of organic fertilizers in the management of nutrient deficiency, acidity, and toxicity in acid soils – A review. *J. Glob. Agric. Ecol.* 12, 19-30.
- Michael, P. S., 2022. Research needs in agriculture and other land use in response to the green economy – A review. *J. Glob. Agric. Ecol.* 14, 97-104.
- Michael, P. S., Fitzpatrick, R., Reid, R. 2015. The importance of organic matter on amelioration of acid sulfate soils with sulfuric horizons. *Geoderma.* 225, 42-49.
- Michael, P. S., Fitzpatrick, R., Reid, R., 2016. The importance of soil carbon and nitrogen in amelioration of acid sulphate soils. *Soil Use Manage.* 32, 97-105.
- Michael, P. S., Fitzpatrick, W. R., Reid, J. R., 2017. Effects of live wetland plant macrophytes on acidification, redox potential and sulfate content in acid sulphate soils. *Soil Use Manage.* 33, 471-481.
- Michael, P. S., Reid, J. R., 2018. The combined effects of complex organic matter and plants on the chemistry of acid sulfate soils under aerobic and anaerobic soil conditions. *J. Soil Sci. Plant Nut.* 18, 542-555.
- Michael, P. S., Reid, R., Fitzpatrick, R. W., 2012. Amelioration of slowly permeable hypersaline peaty-clayey sulfuric and sulfidic materials in acid sulfate soils by mixing with friable sandy loam soil. In: Burkitt, L. L., Sparrow, L. A. (eds.), *Proceedings of the 5th Joint Australian and New Zealand Soil Science Conference: Soil solutions for diverse landscapes.* Hobart, Tasmania, Australia, pp. 146–149.
- Michael, P. S., Reid, R., Fitzpatrick, W., 2013. Biological assessment of the effects of acid soils on plant biomass production at Toora, Lower

- Murray River Basin, South Australia. Environ. Papua New Guinea. 2, 23-31.
- Nathan, M. V., 2021. Soils, plant nutrition and nutrient management, in: Missouri Master Gardener Core Manual. Soil Testing and Plant Diagnostic Services Laboratory, MU Extension, University of Missouri, USA.
- Nordmyr, L., Åström, M., Peltola, P., 2008. Metal pollution of estuarine sediments caused by leaching of acid sulphate soils. Estuar. Coast. Shelf Sci. 76, 141-152.
- Oliveira, A., Pampulha, M.E., 2006. Effects of long-term heavy metal contamination on soil microbial characteristics. J. Biosci. Eng. 102, 157-161.
- Powell, B., Martens, M., 2005. A review of acid sulphate soil impacts, actions and policies that impact on water quality in Great Barrier Reef catchments, including a case study on remediation at east Trinity. Mar. Pollut. Bull. 51, 149-164.
- Rahman, M., Lee S-H, Ji, H., Kabir, A., Jones, C., Lee, K. W., 2018. Importance of mineral nutrition for mitigating aluminum toxicity in plants on acidic soils: current status and opportunities. Int. J. Mol. Sci. 19, 3073.
- Reid, R. J., Butcher, C. S., 2011. Positive and negative impacts of plants on acid production in exposed acid sulphate soils. Plant Soil. 349, 183-190.
- Roos, M., Astron, M., 2005. Hydrochemistry of rivers in an acid sulphate soil hotspot area in western Finland. Agric. Food Sci. 14, 24-33.
- Sharma, P. K., Mishra, B., 2001. Effect of burning rice and wheat crop residues: loss of N, P, K and S from soil and changes in nutrient availability. J. Indian Soc. Soil Sci. 49, 425-429.
- Soil Survey Staff. 2014., Keys to Soil Taxonomy. 20th edn. USDA NRCS, Washington, D.C.
- Soil Survey Staff., 2017. Soil Survey Manual. USDA NRCS, USA.
- Steiner, C., 2007. Soil charcoal amendments maintain soil fertility and establish carbon sink-research and prospects, in: Li T. X. (ed.), Soil Ecology Research Developments. Nova, New York, Pp. 1-6.
- Tabitha, T. B., Richard, T. K., David, R. H., James, B. H., Richard, E. R., 2008. Lime effects on soil acidity, crop yield, and aluminum chemistry in direct-Seeded cropping systems. Soil Sci. Soc. Am. J. 72, Pp. 634-640.
- Tang, C., Rengel, Z. 2003. Role of plant cation/anion uptake ratio in soil acidification, in: Rengel, Z. (ed.), Handbook of Soil Acidity. Dekker, New York, Pp. 57-81.
- Toan, N. B., Debergh, P. C., 2004. Tissue culture approaches for the selection of aluminium-tolerant Citrus species in the Mekong Delta of Vietnam. J. Hort. Sci. Biotech. 79, Pp. 911-916.
- Tully, K., Sullivan, C., Weil, R., Sanchez, P., 2015. The state of soil degradation in Sub-Saharan Africa: baselines, trajectories, and solutions. Sustainability. 7, Pp. 6523-6552.
- Vegas-Vilarrubia, T., Baritto, F., Melean, G., 2008. A critical examination of some common field tests to assess the acid-sulfate condition in soils. Soil Use Manage. 24, Pp. 60-68.
- Walker, D. J., Clemente, R., Bernal, M. P., 2004. Contrasting effects of manure and compost on soil pH, heavy metal availability and growth of *Chenopodium album* L. in a soil contaminated by pyritic mine waste. Chemosphere. 57, Pp. 215-224.
- Wang, J., Raman, H., Zhang, G., Mendham, N., Zhou, M., 2006. Aluminium tolerance in barley (*Hordeum vulgare* L.): physiological mechanisms, genetics and screening methods. J. Zhejiang Univ. Sci. B. 7, Pp. 769-787.
- Ward, N. J., Sullivan, L. A., Bush, R. T., 2004a. The response of partially oxidised acid sulfate soil materials to anoxia. Soil Res. 42, Pp. 515-525.
- Ward, N. J., Sullivan, L. A., Bush, R. T., 2004b. Soil pH, oxygen availability, and the rate of sulfide oxidation in acid sulfate soil materials: implications for environmental hazard assessment. Soil Res. 42, Pp. 509-514.
- Wilson, B. P., 2005. Elevations of sulfurous layers in acid sulfate soils: What do they indicate about sea levels during the Holocene in eastern Australia? Cartena. 62, Pp. 45-56.
- World Geography., 2023. Humid tropical climate. <https://www.insightsonindia.com/world-geography/physical-geography-of-the-world/climatology/world-climatic-regions/koeppens-classification/humid-tropical-climate/>. Accessed 7th July, 2023.
- Xu, J. M., Tang, C., Chen, Z. L., 2006. The role of plant residues in pH change of acid soils differing in initial pH. Soil Biol. Biochem. 38, Pp. 709-719.
- Xu, R. K., Coventry, D. R., Farhoodi, A., Schultz, J. E., 2002. Soil acidification as influenced by crop rotations, stubble management and application of nitrogenous fertiliser, Tarlee, South Australia. Aust. J. Soil Res. 40, Pp. 483-494.
- Yang, R., Mitchell, C. C., Howe, J. A., 2018. Relative neutralizing value as an indicator of actual liming ability of limestone and byproduct materials. Commun. Soil Sci. Plant Anal. 49, Pp. 1144-1156.
- Zingore, S., Mutegi, J., Agesa, B., Tamene, L., Kihara, J., 2015. Soil degradation in sub-Saharan Africa and crop production options for soil rehabilitation. Better Crops. 99, Pp. 24-26.

